

LBS CURVES

Curve Shelves On Curved Frames
(Frames/Shelves Forming A Circle)

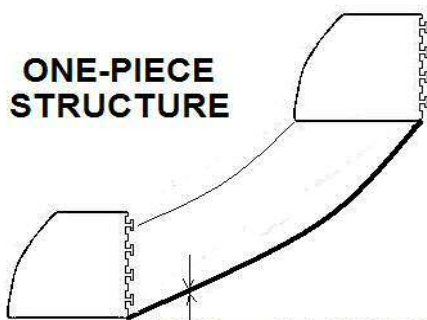

ONE-PIECE
STRUCTURE

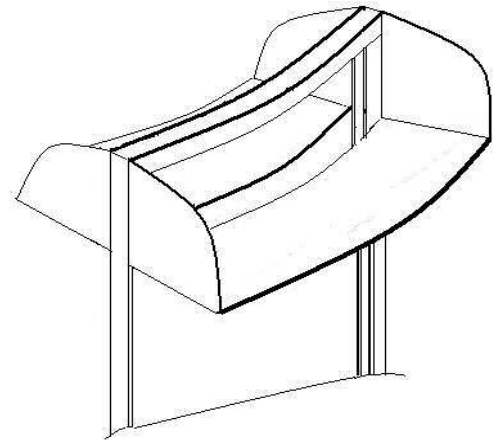
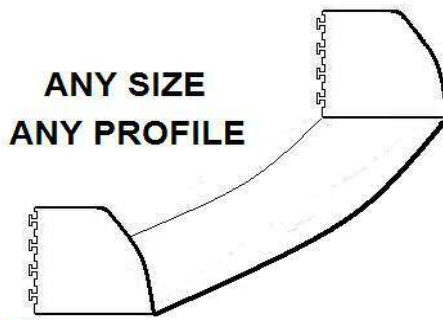

ANY SIZE
ANY PROFILE

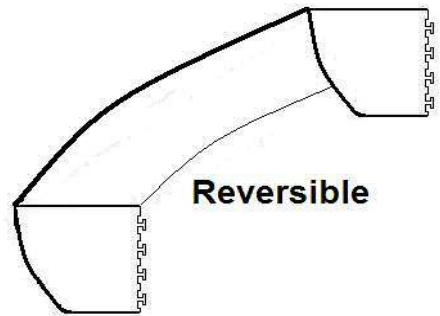

Reversible

1/16" and 3/32" Thick

Also Available (on LBS Standard Frames):

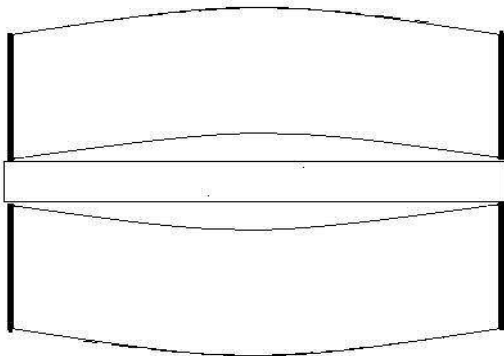

CONVEX

Convex Shelves On Straight Frames

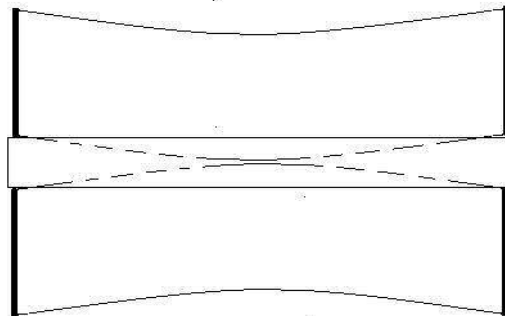

CONCAVE

Concave Shelves On Straight Frames

Note: Double Face Shown



LBS NEW PRODUCT

LBS CURVE LAYOUTS

UNIT DEPTHS:
 16" - 18" - 20" - 22"
 24" - 26" - 30" - 32"
 (Nominal)

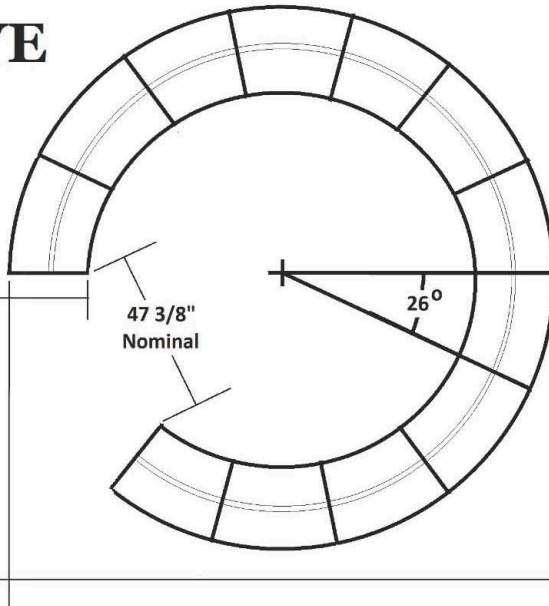

CORRESPONDING
 ASSEMBLY RADIUS:
 150" - 154" - 158" - 162"
 166" - 170" - 178" - 182"
 (Nominal)

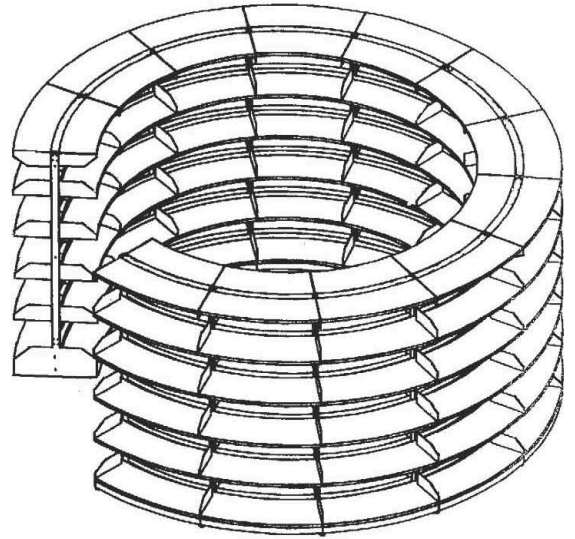

NOTE:
 3 1/8" High Kick Base - Standard
 Stacked Kick Bases in 3 1/8" Increments
 Available in 2 and 3 Color Max 9 1/2" High

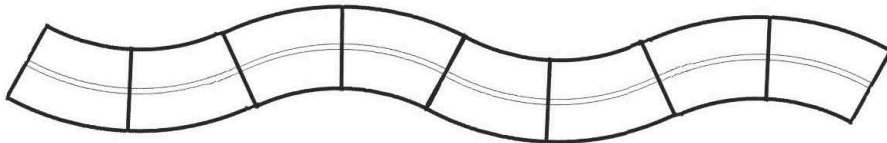
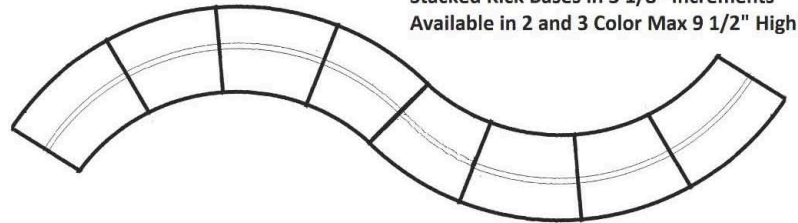
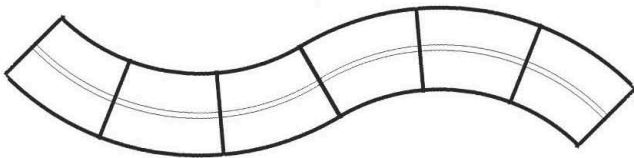

NOTE:
 Standard Welded Frame in all Heights
 Seismic Welded Frames Available
 Curved Adjustable Backstops Available

